

ETIPESE®



MC 1100

Instruction manual
International Version



Congratulations ! You now own one of the most sophisticated and experienced pigeon identification and racing real time systems on the market. TIPES[®] is a simple-to-use system that allows precise and automatic measurement of pigeon racing performance.

Naturally, you can't wait to get this state of the art equipment running, but before you start, it's worthwhile taking the time to read through this manual. Once you know about the features of TIPES[®] MC1100, trouble-free operation is guaranteed.

Please check if your TIPES[®] is complete while you are unpacking the cardboard box. Make sure that no items are left inside the box. You should keep the TIPES[®] cardboard box for future transportation or storage purposes.

Table of contents

1. PREVIEW	5
Safety instructions and precautions.....	5
2. COMPONENTS OF THE TIPES[®] SYSTEM	6
The TIPES [®] -Ring MC 601	6
The electronic trap (USTB or normal trap).....	6
The reading unit	6
The Basketing unit	7
PC / Computer.....	7

3. TIPES® MC1100 SYSTEM CONFIGURATIONS AT YOUR LOFT 7

Connecting MC1100 to TIPES older TIPES equipment..... 7

Connecting MC1100 within USTB environment..... 8

Connecting MC1100 to basketing unit 8

4. OVERVIEW OF CONNECTORS AT MC1100..... 11

5. DESCRIPTION OF MC1100 CONNECTORS 12

Basketing unit / Reading unit Connector (AUX)..... 12

UniversalSerialTipesBus Connector (USTB)..... 12

6. HOW TO USE TIPES MC1100 MASTER? 12

Programming fanciers data from PC 15

Deleting fancier 15

7. MC1100 MASTER FUNCTIONS 15

Basketing..... 15

Closing knockoff..... 19

Allocate 19

PC-Communication..... 20

Print..... 21

 Basketing List (Race entry form):..... 22

 Race result List (Clockroll):..... 23

 Allocation list..... 23

Gambling (Picked Birds and Nominations) 24

 Nominations..... 25

 Picked birds 25

Delete..... 26

Setup..... 27

Training basketing 28

Selftest 29

Time /Date..... 29

Race Info 29



9. SOFTWARE UPDATE	30
10. DIRECT ACCESS FUNCTIONS.....	30
11. DR. MC TIPES	32
12. TECHNICAL DATA	33
13. GUARANTEE-CONDITIONS:	33
14. IMPRINT	34

1. Preview

TIPES[®] MC1100 clock is based on modern radio and computer technology developments and offers a variety of advantages for you as well as for your club.

- Automatic pigeon identification for up to 500 birds
- Automatic basketing and clocking capability for up to 500 birds
- Up to 50 liberation points programmable
- Print out of race entry form and clock roll on serial printer during clocking the birds via reading unit or club unit.
- Automatic satellite based clock setting at the club and automatic time adjustment for your local time
- Additional Battery-Backup-adaptor enables you to connect a 12-volt-backup supply with automatic switch-over in case of main power interruption
- Full graphic display for more and detailed information
- Continuously clocking
- Up to 4 traps can be connected at the USTB (Universal Serial TIPES Bus) Interface
- Fully compatible to older versions of TIPES systems.

Safety instructions and precautions

The manufacturer cannot be held responsible for any damage which is incurred by not using TIPES[®] in compliance with the following safety instructions.

First check if your supply voltage is the same as that written on the type plate on the bottom of your TIPES[®] reading unit. Use only original TIPES components.

TIPES[®] does not contain any parts that can be repaired by the user. Any attempt to open one of the TIPES[®] units is made visible as the units are sealed. Please note that destroyed seals make all stored race data invalid. The units may only be opened by authorized TIPES[®] service personnel.

For system setup refer to this manual and to the mounting instructions for the electronic trap. For setup of the race office please refer to the master unit manual.

To switch off TIPES[®] completely you must disconnect the MC1100 from the power supply. If the MC1100 is connected to a reading unit, then power off of this.

Protect the MC1100 clock and all other TIPES units as well as all connectors from rain and moisture. Make sure that the electronic trap is not placed in a puddle during rain. The trap installation should provide proper draining of water.

Do not place the MC1100 clock close to sources of heat such as radiators etc.

The MC 1100 clock and other TIPES units except traps should only be used inside a building. Do not use these units immediately after moving them from a cold to a warm location. Before powering, on allow at least 60 minutes to acclimatize.

Any change or modification of the TIPES[®] system or a component of this system requires explicit written approval of the manufacturer. Unauthorized modification does abolish the general operation agreement.

2. Components of the TIPES® system

Let's have a closer look at the TIPES® components now. A short overview will give you information concerning the purpose of each individual unit so that you can easily understand the way the system works.

The TIPES®-Ring MC 601 / MC 603

In addition to the usual association ring each pigeon that shall be detected and identified by TIPES® needs to wear a TIPES® ring. This very light plastic ring carries an electronic identification circuit that transmits its electronic ring number to the electronic trap. This electronic ring number enables the TIPES® system to identify each individual pigeon passing the trap. The manufacturer guarantees that each electronic ring has a unique number, worldwide. The electronic circuit in the TIPES ring is additionally protected against shock and drop downs through a glass cover.

In addition the TIPES® ring features a special anti-deception circuit. Before each race when the pigeons are basketed with the master unit (race office unit) the ring electronics will generate a random number which is rechecked when the arriving pigeon is detected by the electronic trap.

The electronic trap (USTB or normal trap)

The electronic trap offers automatic detection capability for TIPES® rings. The trap is powered from the MC1100 automatically. Your pigeons will get used to the trap quickly. They will accept entering the loft through this entrance when they learn that they are no longer caught after racing. Please refer to the trap mounting instructions for proper setup and installation.

Please note that the driver capabilities have a maximum up to 4 antennas on the USTB connector. You could check the power consumption by the LED of the end of line connector. Please refer to the manual of the USTB antennas.

The reading unit

The reading unit (Professional) contains a switch mode power supply and generates all supply voltages necessary to power the trap(s) as well as the MC 1100. The reading unit (Junior) has an external power supply that provides all supply voltages necessary to power the trap(s) as well as the MC 1100. The electronic ring numbers detected by the trap are transferred to the reading unit via the trap cable that is connected to the trap inputs on the rear of the reading unit. This data is immediately sent to the MC 1100 which must be connected to the matching connector at the front of the reading unit:

Note:

If you want to connect more than three traps to your reading unit, then you are in need of a TIPES®-SUPRA that enables you to connect up to five traps to your reading unit. With additional TIPES®-SUPRAs you can increase the number of traps up to 18 ! Please contact your distributor for more information.

The connector for the radio clock located on the rear of the reading unit is only used in Germany, Austria, Switzerland and Denmark. The internal clock of your TIPES® MC 1100 will be adjusted by the master unit whenever pigeons are basketed.

The Basketing unit

The Basketing unit is used together with MC1100 for allocation and basketing. Doing the allocation procedure you have to connect a pc additionally to the basketing unit. This is used to assigned the electronic ring no. to the association ring no. of the pigeon.

The basketing is used to put your pigeons on a official race. For more details please refer to basketing unit manual.

PC / Computer

The PC is used for setting up the database for the fancier and does the allocation procedure before the race starts. After the race you transmit the data from MC1100 to the PC automatically for calculation the race results.

3. TIPES® MC1100 system configurations at your loft

MC1100 allows you a variety of configurations. It is fully compatible to the former TIPES versions (Control unit, reading unit). For more details please contact your TIPES dealer.

Connecting MC1100 to TIPES older TIPES equipment

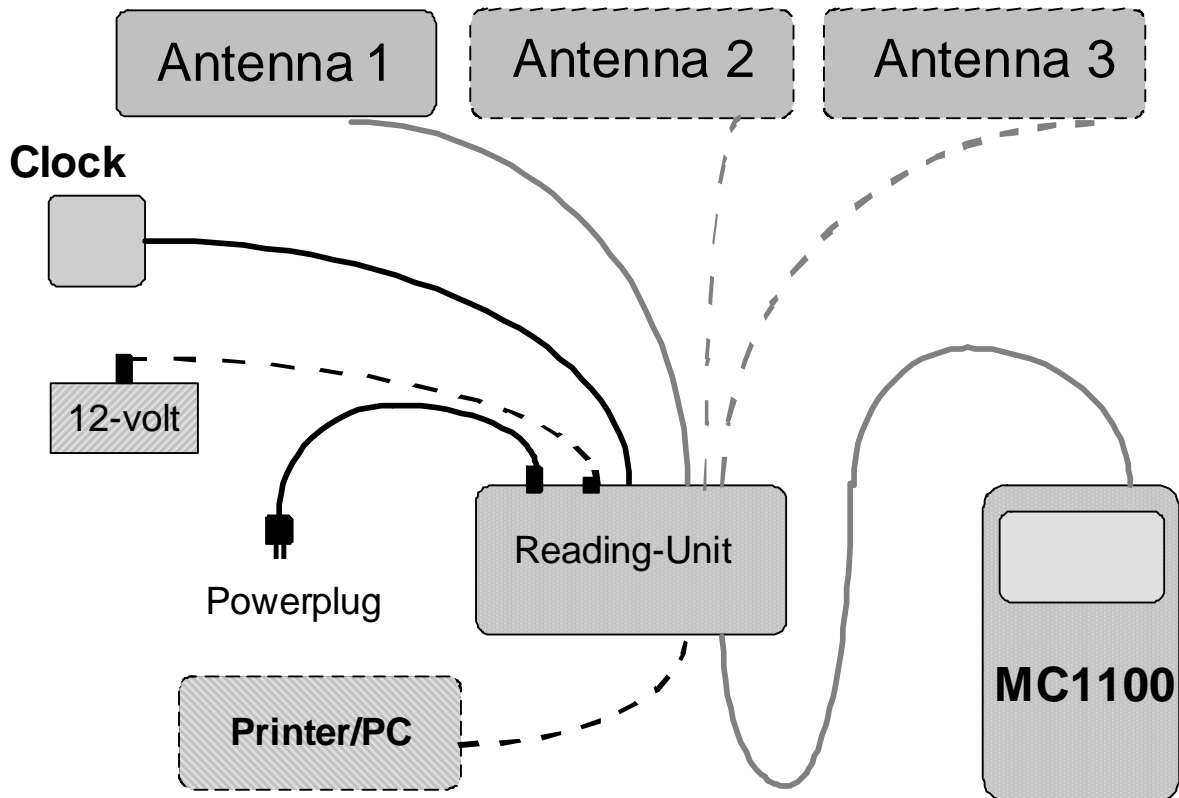

Connection schematic

The MC1100 is able to substitute the control unit completely. It supports every kind of reading unit (normal or continuously clocking) without any hard- or software changes to your system.

Connecting MC1100 within USTB environment

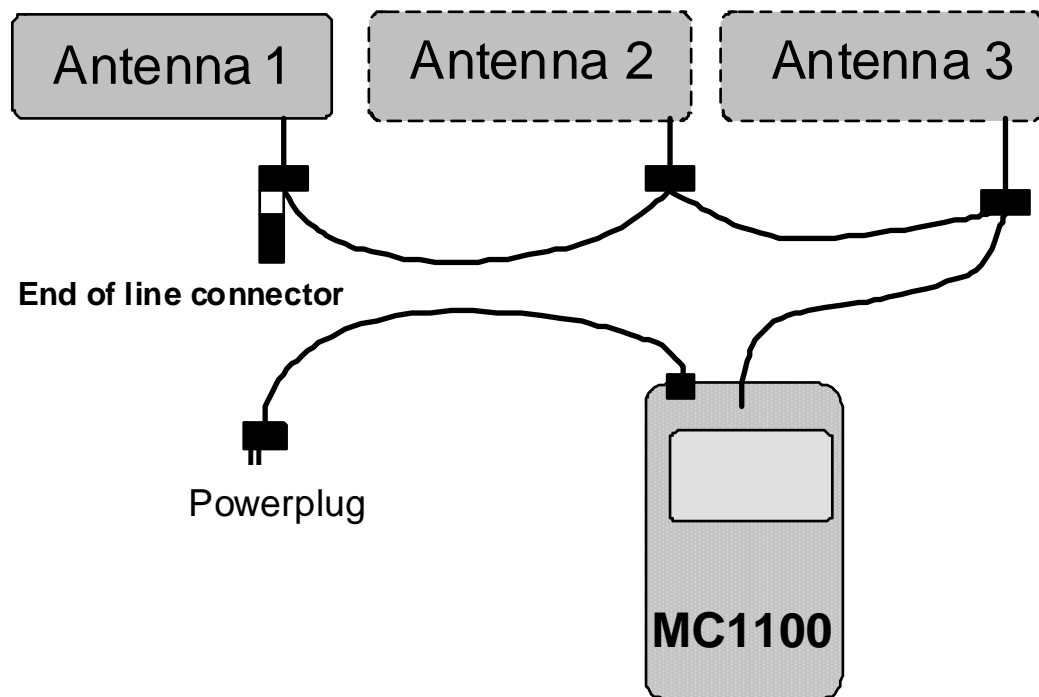

If you want to connect a 12 V accumulator or a battery for power backup functions please use a backup adapter. For set up those please refer to the manual.

Connecting MC1100 to basketing unit

The Basketing unit is used together with MC1100 for allocation and basketing. Doing the allocation procedure you have to connect a pc additionally to the basketing unit. This is used to assigned the electronic ring no. to the association ring no. of the pigeon.

The basketing is used to put your pigeons on an official race. For more details please refer to basketing unit manual.

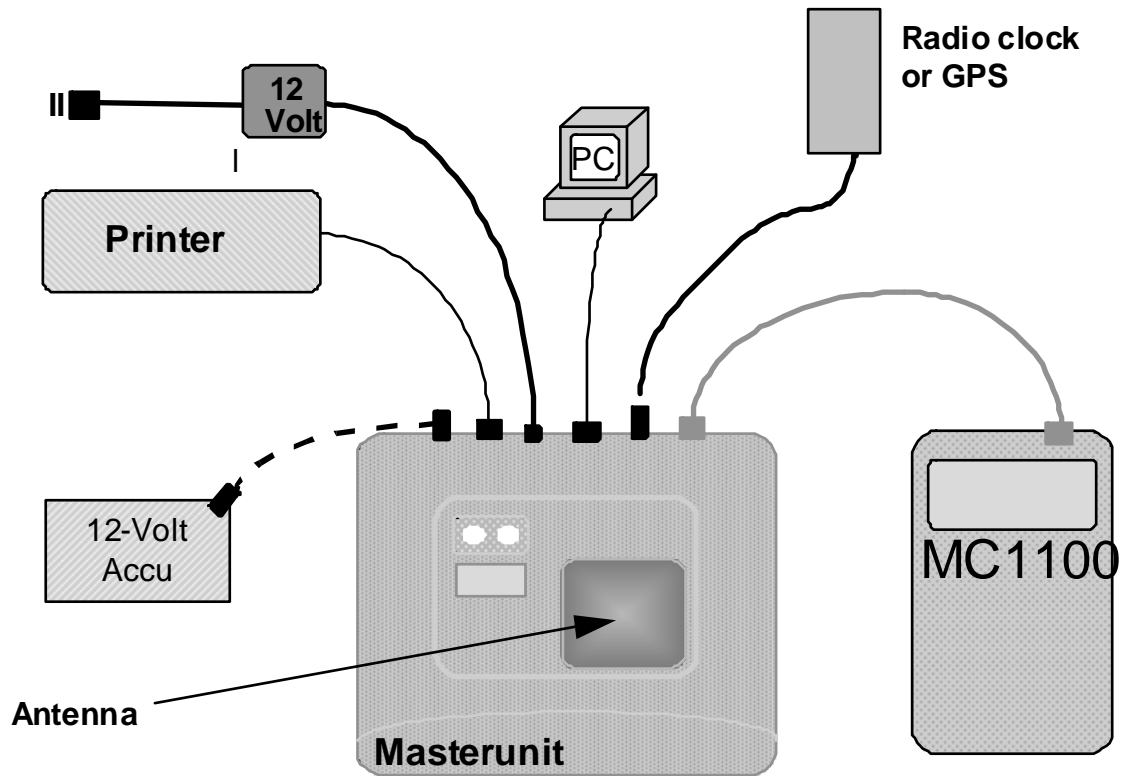

Connection

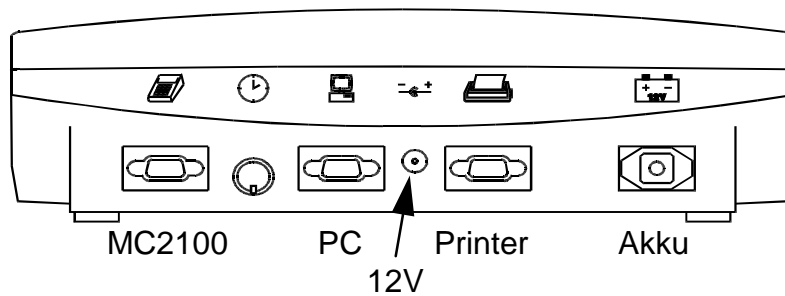

Picture: rear view of the Basketing unit

If the Basketing unit is connected to the power supply, the short simultaneous flashing of the green and the red light shows that the self-test of the Basketing unit is ok.

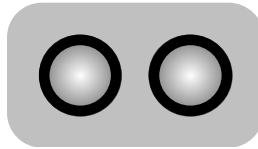

both lights flash
SELF-TEST is running

If both lights are extinct, the Basketing unit is ready.

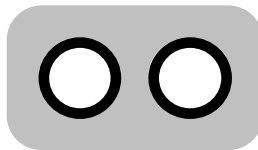

both lights extinct
Basketing unit ok

If only the green light extinct after the self-test and the red light is still on, the self-test has detected an error. In this case switch power off and on again. If the red light is still on please contact your next TIPES dealer or one of our customer service partner.

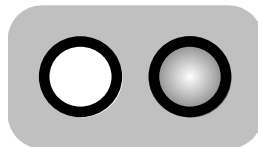

red light on
ERROR!

4. Overview of connectors at MC1100

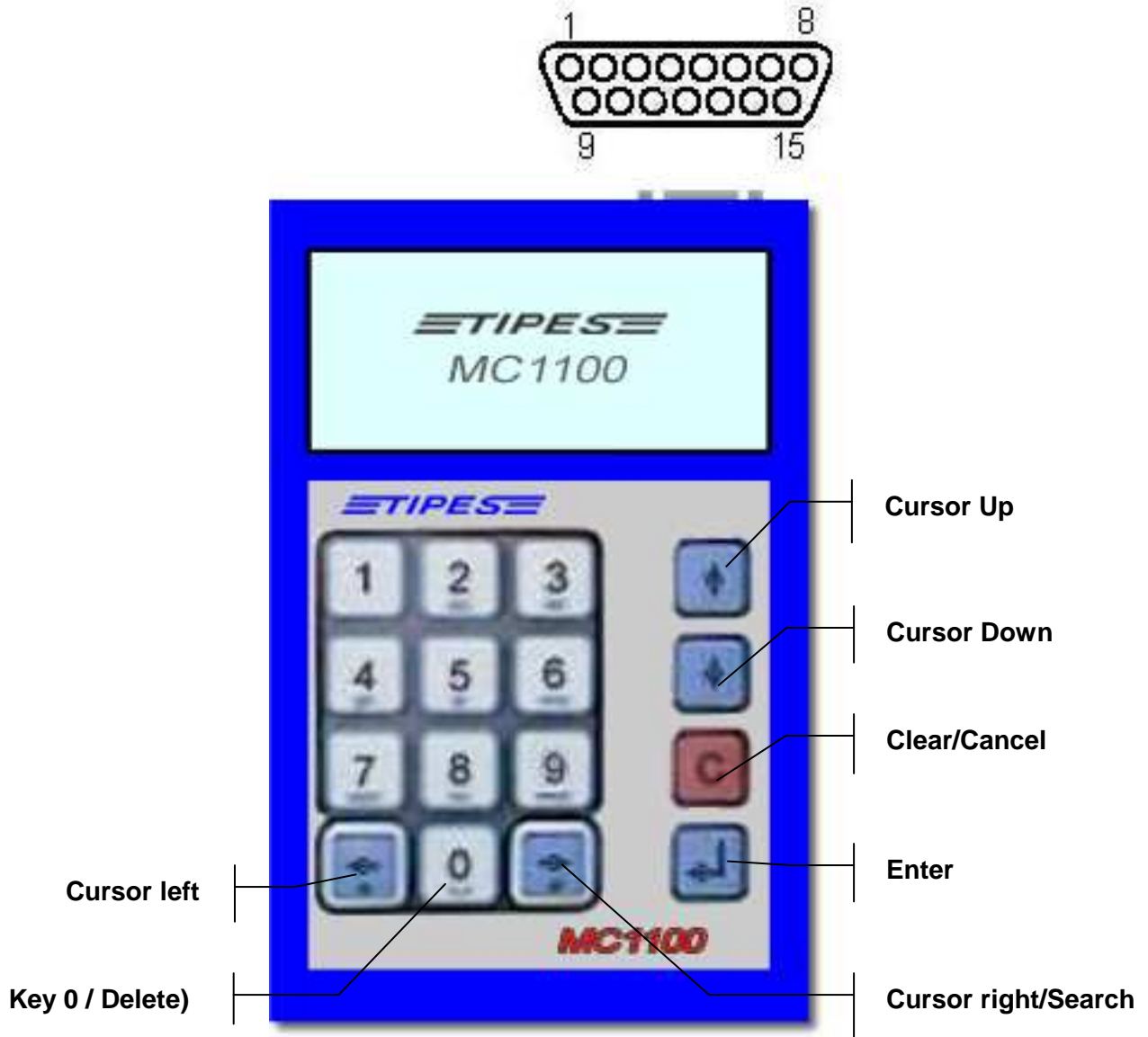

5. Description of MC1100 connectors

Multifunction port

Basketing unit / Reading unit Connector

This connector gives you the possibility to connect the MC1100 clock to your old TIPES equipment. It is also used to connect MC1100 master to your basketing unit, for doing the allocation, basketing or communication procedure in the club.

UniversalSerialTipesBus Connector

On the USTB (Universal Serial TIPES Bus) you can connect several types of traps (1-, 2- or 4-field traps, continuously clocking device). Also additional hardware, which will be developed in the future will be connected to the Multifunction port. The USTB is designed to connect one unit to the other. No additional hardware is needed to interconnect every unit on USTB.

Please take care about the power consumption and use every 3 traps a T-adaptor to refresh the power. Additionally please check the light at the End-of-line connector, which must be connected to the last device of your system. If the red light at the End-of-line connector is flashing continuously it indicates that the supply voltage is too less and your system maybe would not detect pigeons. To solve this problem please connect a T-adaptor between the last trap and the trap before.

Every connected device can be identified independently, which gives the MC1100 clock the possibility to detect faulty devices or line interruptions.

The maximum total length of the USTB bus could be extended up to 1000 m. In this case you have to monitor the End-of-line connector carefully for power consumption indication. For that special purpose please contact your TIPES dealer or the manufacturer.

The MC1100 system supports up to 4 antennas connected via USTB bus.

6. How to use the TIPES MC1100 clock?

This chapter will show you how TIPES® supports your activities before, during and after pigeon races. Whenever you don't know how to leave a certain input position press the 'C' key or just disconnect the MC1100 master from power supply. After power on you will automatically get to the main menu where all step by step descriptions start. Your stored data is saved even when you turn off the power supply.

The software for the MC1100 is divided into 3 operation modes:

1. CLUB MODE

This mode is automatically activated when the MC1100 clock detects a basketing unit connected. You have a number of subsets to service all functions regarding the basketing, allocation, printing, pc communication procedure or additional necessary functions (deleting, setup) for that purpose.

2. HOME MODE

This mode is automatically activated when the MC1100 clock detects a reading unit with connected traps or USTB units (traps) connected. You have a number of subsets to service all functions regarding the registration, printing, nomination, information procedure or additional necessary functions (deleting, setup) for that purpose.

A special functionality in HOME mode is the Continuously Clocking function. This function is available with a special reading unit connected to the multifunction port connector. For more details please refer to the special manuals.

3. SINGLE MODE

The single mode is entered automatically when no peripheral unit is detected. Here you can start the nomination, deleting, setup, etc. function.

The menu structure is setup with icons at the bottom of the display and additional text above for more details.

Every function (Basketing, Allocation, etc.) of MC1100 master could be reached through the Direct Access Function (Short Cut). For detailed description please refer to chapter 10.

For every key of the keyboard an auto repeat function is available. This function is started after you hold the key pressed for more than 1 s.

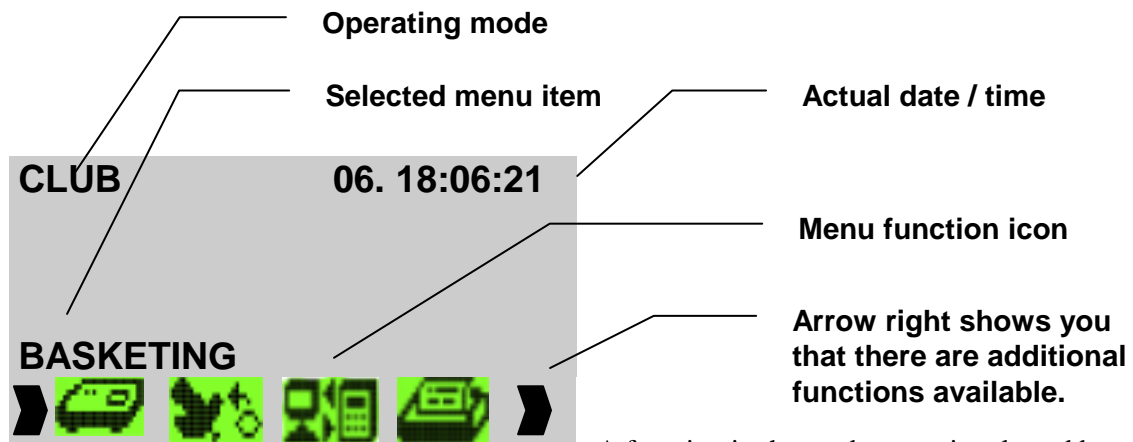

A function in the mode menu is selected by pressing the arrow right key for forward selection and the arrow left key for backward selection. For starting the function you have to press the RETURN key (↵).

Every menu offers various possible functions. The step by step description in the next chapter will show you in detail how to operate the TIPES® MC1100 clock.

The next chapter will show you how TIPES® supports your activities before, during and after pigeon races. Whenever you don't know how to leave a certain input position just switch off the reading unit. After power on you will automatically get to the main menu where all step by step descriptions start. Before the main menu is entered you will see the start up window and the configuration window. The startup window includes the general information about the system (Manufacturer, dealer, software version and serial number). The information in the configuration window is very important, because it shows you information about the connected units of your TIPES system. You should have a look at it every time you start your system. You could also reach this window again from the main menu, when you press the CANCEL ('C')key.

Please take care about warning messages, because these are related to the safety of operation of all connected units of MC1100 system.

All units, which could be connected to the MC1100 clock will be shown in the configuration window. Please refer to the following symbols:



Basketing unit is connected



Reading unit is connected



Reading unit with continuously clocking feature is connected



USTB traps are connected – Additionally on the left angle corner the number of traps which are connected, are displayed.



No unit connected.



Programming fanciers data from PC

If you want to program a new allocation table into the MC1100 clock please program first the fanciers data or if already done, please select the fancier in the configuration window. For communication please refer to chapter pc communication.

Deleting fancier

To delete fanciers data please select the fancier in the configuration window and press the „0“ key. Afterwards you have to put in the pin code of this fancier (It's the same he uses for deleting race data).

7. MC1100 master functions

In the following will give a detailed description of all available functions and in which mode it can be operated.



Basketing

Only available in CLUB mode.

This chapter describes how you get your pigeons registered with the basketing unit. During the basketing procedure the internal clock of your MC 1100 is automatically adjusted by the basketing unit. The time signal is sent from the satellites of the global positioning system (GPS) which works in every area of the world.

Use the basketing unit for basketing !

Make sure that the (GPS) time receiver is connected to the master unit.
Connect your MC 1100 to the master unit.

If no signal is responded from the time receiver the red light at the basketing unit will switch on. In that case please turn off the basketing unit for a few seconds and power up again without a MC1100 clock connected.

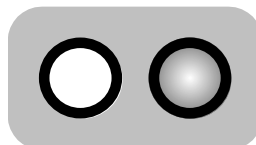

In case of time receiver problems the red light will switch on

If there is a GPS time receiver connected the number of satellites are indicated through the flashing of the green light. The number of short flashes after a longer switched off period shows the received

satellites. The GPS requires signals from 4 satellites. Move the time receiver antenna if the number of detected satellites does not reach this value. Satellite search takes a few minutes. Best performance is guaranteed in open air. Concrete walls and buildings diminish the radio signal strength.

This time adjustment will start automatically if the internal clock of the master unit has not been adjusted within the last 24 hours. Normally the first control unit connected to the master unit will start the GPS satellite search when the basketing mode is selected. The internal clock of all following MC1100 masters will then be adjusted from the basketing unit clock automatically.

Satellite search may be skipped in case the GPS has been connected to the basketing unit several minutes before the first MC1100 master is connected for basketing. Satellite search may have already completed

After successful time adjustment you have select the liberation point. Please note, before you could start the basketing procedure you have to upload a set of liberation points from PC administration software to the MC1100 clock. Please refer to chapter PC communication or PC administration software manual.



Please note, that if you didn't upload liberation points to the MC1100 clock you will have the default programmed liberation points, like 1-1, 1-2, 1-3, ...

Move the selection bar to the liberation point on which you want to basket your pigeons. Press ENTER to select it.

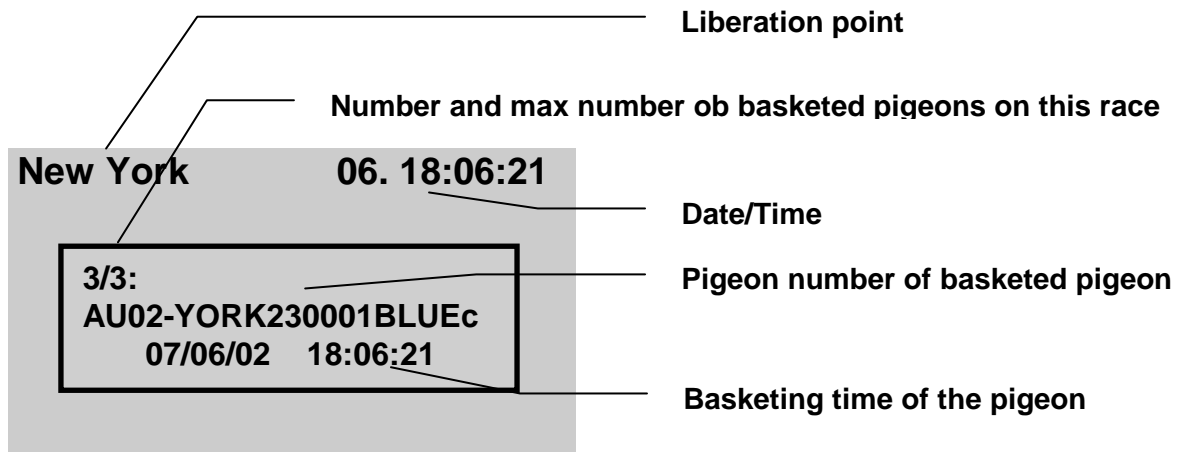

Please put your pigeons one after the other on the basketing unit and listen to the beep that indicates successful basketing. The following picture shows how to use the basketing unit to get the pigeon basketed.

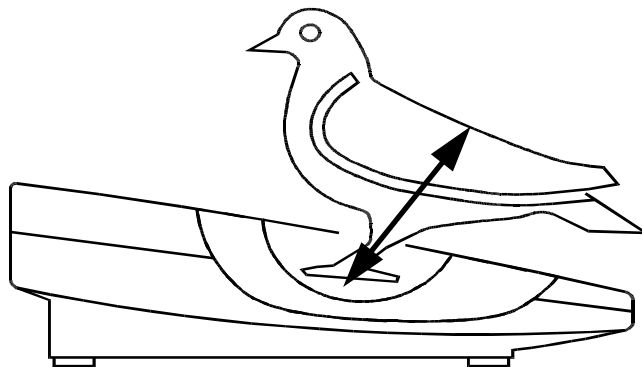

The green light switch on for approximately 1 second that shows you that the pigeon is basketed successfully.

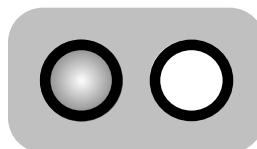

green light on
O.K.

If the red light switches on, it indicates that something is wrong with the electronic ring. Please put the ring again into the whole of the basketing unit. If the red light switches on again you have to replace this ring by a new one, because it's defective.

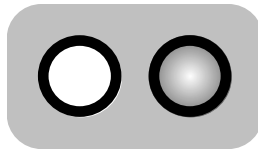

red light on
DEFECTIVE RING

Allocation during basketing procedure

As you know from some older TIPES control unit versions you are able to allocate a pigeon during basketing without a pc connected. Every version of the MC1100 clock has implemented that function as a standard. This function should be used in case of emergency when a pigeon ring get defective. For successful allocation the ring number of the pigeon must be a member of the already uploaded allocation table.

In basketing mode the system automatically recognize a not allocated electronic ring, when you put it on the basketing unit.

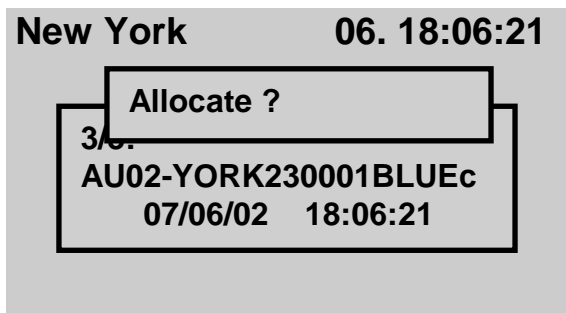

Press the ENTER key if you want to allocate the registered electronic ring to a pigeon. If not press the 'C' key and the allocation procedure will be cancelled.

To select the pigeon you want to allocate, happens in two ways:

1. Move the selection bar with the up and down key to the pigeon
2. Press the right arrow key and input the last 4 digit of the association ring number

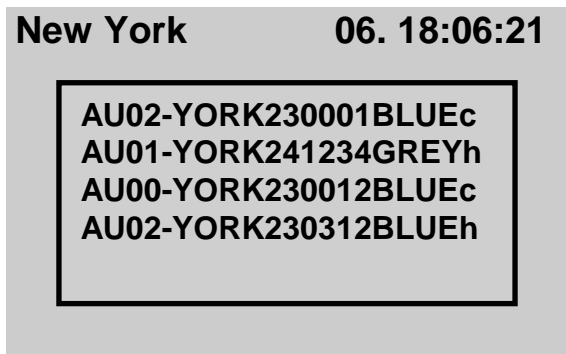

Moving the selection bar to select pigeon association ring number

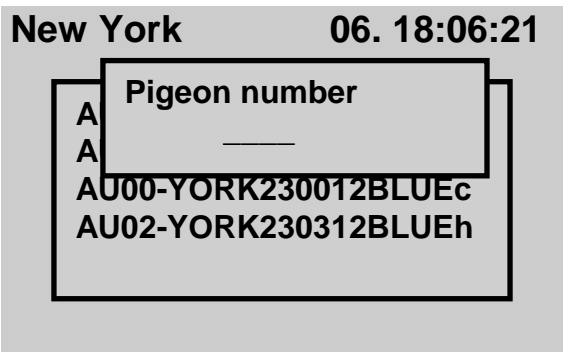

Use the search function to select the association ring number
Press the right arrow key and put in the last 4 digits of association ring number. If the pigeon is existing in the allocation table the selection bar will be automatically set to this pigeon.
Press the ENTER key to select it.



Closing knockoff

Only available in CLUB mode.

This function enables you to generate a closing knockoff together with connected basketing unit. No print out will be generated. The print out of the race result list could be done easily in HOME mode with a connected serial printer via reading unit.



Please select the liberation point and press the RETURN key (↵) to start the closing knockoff. The closing knockoff time will be automatically generated and store to the related liberation point.
In the next step of this function you have release the birds for deleting. If you don't want to release press 'C'.



Allocate

Only available in CLUB mode.

The MC1100 clock needs to know the electronic number of each TIPES® ring that is attached to your pigeons. The MC1100 clock can store a cross reference table with all your pigeons association numbers and the matching electronic numbers of the TIPES® rings. This table enables your TIPES® to always display the association numbers you are familiar with.
Now let's see how your MC1100 clock „learns“ all those numbers:

Use the master unit for allocation !

Make sure that the basketing unit is connected to the club personal computer via the PC interface. Refer to the master unit (race office unit) manual for detailed setup instructions.

The administration software has to run and the allocation mode has to be selected. Please refer to the administration software manual.

Connect your MC1100 clock to the basketing unit .

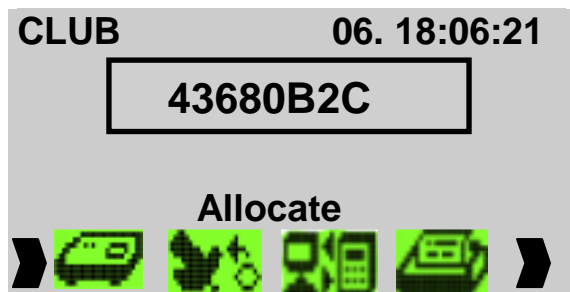

Select the **ALLOCATE** function with the ⇒ ⇐ (right/left) keys
Press the ENTER key

This number instantly disappears from the display to the personal computer when the „Allocate“ command is entered. There it is matched in the cross reference table to the association (metal ring) number preselected by

the PC operator.

If all your pigeons have been allocated disconnect the MC1100 clock from the master unit. The cross reference table now has to be copied into the control unit. If all pigeons are allocated, press the 'C' key to enter the main menu. Select pc communication to upload the allocation table into the MC1100 clock. Please refer to chapter pc communication for data transfer and for more details basketing unit and pc administration manual.



PC-Communication

Only available in CLUB mode.

Your TIPES® is able to exchange data with an Windows PC. Data transfer is required to

- Store and restore an allocation table into the MC1100 clock
- Store fanciers identification data into the MC1100 clock
- Transfer and delete liberation points
- Change the PIN secret code (see chapter Delete)
- Read race results from the MC1100 clock.

Connect your MC1100 clock to the basketing unit. The personal computer has to be connected to the PC connector at the rear of the basketing unit.

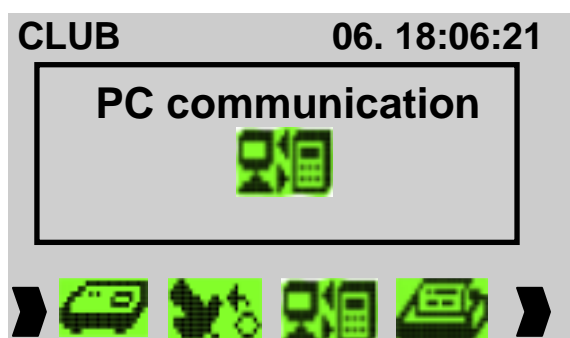

Select the **PC communication** function with the ⇒ ⇐ (right/left) keys
Press the ENTER key

During transmitting or receiving data an arrow at the MC1100 clock's display will show the direction of the data transfer. For detailed information please refer to the pc administration software manual.

You can cancel the pc communication menu by pressing the 'C' key.

Particularities during programming the liberation points

If you want to upload liberation points, which are defined by yourself, first you have to delete the default liberation points, which are setup during initialisation. Otherwise they will be merged to the existing liberation point table in your MC1100 clock.

MC1100 clock gives you the possibility to upload up to 50 different liberation points.

In order to remove liberation points from the MC1100 clock, you have to run the function „Delete“ in the administration-software, submenu liberation points.



Print

Available in CLUB mode and in HOME via reading unit

Club mode operation

TIPES® can generate printouts of basketed pigeons after basketing or of registered pigeons after a training flight or a race. You can print via the basketing unit on a serial printer. For official races you have to use the basketing unit to generate the closing knockoff.

Use the master unit for the printing of „official“ clockrolls!

Make sure that a time receiver is connected to the basketing unit.

Connect your MC1100 clock to the basketing unit.

If you use a serial printer (RS 232 interface) connect it to the printer connector of the basketing unit.

The printer has to be on line; please refer to the printer manual. Presettings for the printer are:

ETIPES

transfer rate: 9600 baud
data size: 8 bit, 1 stop bit
parity: odd
handshake: none

Printing 06. 18:06:21

**Basketing List
Knockoff-List
Allocation-List**

Select the **Print** function with the ⇒ ⇐ (right/left) keys
Press the ENTER key
Move the selection bar to the sub menu item of the list you want to print. Press ENTER to select it.

You are able to print 3 different lists:

- Basketing List
- Knockoff List (Race result list)
- Allocation List

If you print the Basketing or Knockoff List you have to select the liberation point of the race you want print out firstly.

Basketing List (Race entry form):

TIPES MC1100 V2.51INT
Race entry form

Page 1

Date: 11/03/11
Time: 09:37:14
LJ

Breeder No.: 293 01 01 001
Name : usa
Serial No. : E000000130 - C6C6C6C6
Liberation point: 1-1

PB	RT	As.ringNo.	Day	Time	el.ring	Nom	Birds	S	SN	
001	015	US11-	1000015	w	3.	9:35:28	497C3C17	*	2	Yv
002	013	US11-	1000013	w	3.	9:35:30	497C3AE2	*	2	pF
003	007	US11-	1000007	c	3.	9:35:31	497C3D10	*	2	Fn
004	006	US11-	1000006	c	3.	9:35:33	497C3AC5	*	2	Dd
005	001	US10-	1000001	c	3.	9:35:35	497C3D44	*	2	yn
006	005	US11-	1000005	c	3.	9:35:36	497C3C72	*	2	As
007	008	US11-	1000008	c	3.	9:35:38	497C7AC7	*	2	uA
008	017	US11-	1000017	w	3.	9:35:41	497C3AC4	*	2	yd
009	002	US11-	1000002	c	3.	9:35:42	497C3C20	*	2	jw
010	003	US11-	1000003	c	3.	9:35:45	497C3D58	*	2	Xm
011	004	US11-	1000004	c	3.	9:35:47	497C3A4C	*	2	iX
012	010	US11-	1000010	c	3.	9:35:50	497C3C7A	*	2	Cm
013	011	US11-	1000011	c	3.	9:35:52	497C3D06	*	2	Jt
014	009	US11-	1000009	c	3.	9:35:55	497C7C55	*	2	uq
015	014	US11-	1000014	w	3.	9:35:57	497C7C4F	*	2	mp
016	012	US11-	1000012	w	3.	9:35:59	497C7D59	*	2	kk
017	018	US11-	1000018	w	3.	9:36:08	4F35B8B5	*	2	Vn
018	019	US11-	1000019	w	3.	9:36:10	4F35BB1E	*	2	Zw
019	021	US11-	1000021	w	3.	9:36:18	4F35B85A	*	2	ao
020	020	US11-	1000020	w	3.	9:36:22	4F35B861	*	2	IE

Signature

Number of basketed pigeons: 20 Picked birds, not basketed: 0

Starting knockoff: 11/03/11 09:35:17

BB } Signature

Time difference to UTC: 00000 minutes
Serials: 1: 31008118/ TEE400 , 2: 31000021/ TEE4000

Fancier Club Club

Race result List (Clockroll):

TIPES MC1100 V2.51INT
Clockroll

Page 1

Date: 11/03/11

Time: 09:43:19

LZ

Breeder No.: 293 01 01 001
Name : usa
Serial No. : E000000130 - C6C6C6C6
Liberation point: 1-1

No.	PB	RT	As.ringNo.	Day	Timein	el.ring	Nom	Birds	S	SN	
001	019	021	US11-	1000021	w	3.	9:42:02	4F35B85A	!	3	YT
002	018	019	US11-	1000019	w	3.	9:42:04	4F35BB1E	!	3	hN
003	012	010	US11-	1000010	c	3.	9:42:06	497C3C7A	!	3	jH
004	017	018	US11-	1000018	w	3.	9:42:08	4F35B8B5	!	3	fw
005	020	020	US11-	1000020	w	3.	9:42:09	4F35B861	!	3	ZG
006	014	009	US11-	1000009	c	3.	9:42:13	497C7C55	!	3	DE
007	010	003	US11-	1000003	c	3.	9:42:15	497C3D58	!	3	WC
008	009	002	US11-	1000002	c	3.	9:42:16	497C3C20	!	3	kN
009	001	015	US11-	1000015	w	3.	9:42:18	497C3C17	!	3	XN
010	013	011	US11-	1000011	c	3.	9:42:24	497C3D06	!	3	EJ
011	003	007	US11-	1000007	c	3.	9:42:26	497C3D10	!	3	TA
012	007	008	US11-	1000008	c	3.	9:42:28	497C7AC7	!	3	Ri
013	005	001	US10-	1000001	c	3.	9:42:30	497C3D44	!	3	sD
014	002	013	US11-	1000013	w	3.	9:42:32	497C3AE2	!	3	Gk
015	011	004	US11-	1000004	c	3.	9:42:34	497C3A4C	!	3	go
016	016	012	US11-	1000012	w	3.	9:42:35	497C7D59	!	3	PF
017	006	005	US11-	1000005	c	3.	9:42:37	497C3C72	!	3	MA
018	008	017	US11-	1000017	w	3.	9:42:39	497C3AC4	!	3	Xv
019	015	014	US11-	1000014	w	3.	9:42:42	497C7C4F	!	3	eE
020	004	006	US11-	1000006	c	3.	9:42:44	497C3AC5	!	3	xh

} Signature

Number of entry pigeons: 020

Number of timed in pigeons: 020

Last deleting time: 11/03/11 09:35:08

TIPES-time

GPS-time

Starting knockoff:

11/03/2011 09:35:17

BR

Closing knockoff: 11/03/2011 09:43:19

11/03/2011 09:43:19

pz

} Signature

Time difference to UTC: 00000 minutes

Serials: 1: 31008118/ TEE400 , 2: 31000021/ TEE4000, 3: I500002088

Fancier Club Club

Allocation list

TIPES MC1100 V2.51INT
Allocation list

Page 1

Date: 11/03/11

Copyright © 2011

Seite: 23

Motz-Computer
Service und Vertriebs GmbH
Pfennigbreite 20 - 22
D-37671 Hörter
Germany

Breeder No.: 293 01 01 001
Name : usa
Serial No. : E000000130 - C6C6C6C6

Time: 09:43:53
Fo

No.	As.ringNo.		el.ring	No.	As.ringNo.		el.ring		
001	US10-	1000001	c	497C3D44	002	US11-	1000002	c	497C3C20
003	US11-	1000003	c	497C3D58	004	US11-	1000004	c	497C3A4C
005	US11-	1000005	c	497C3C72	006	US11-	1000006	c	497C3AC5
007	US11-	1000007	c	497C3D10	008	US11-	1000008	c	497C7AC7
009	US11-	1000009	c	497C7C55	010	US11-	1000010	c	497C3C7A
011	US11-	1000011	c	497C3D06	012	US11-	1000012	w	497C7D59
013	US11-	1000013	w	497C3AE2	014	US11-	1000014	w	497C7C4F
015	US11-	1000015	w	497C3C17	016	US11-	1000016	w	4F392E3A
017	US11-	1000017	w	497C3AC4	018	US11-	1000018	w	4F35B8B5
019	US11-	1000019	w	4F35BB1E	020	US11-	1000020	w	4F35B861
021	US11-	1000021	w	4F35B85A					

11/03/11 09:07:45

Fancier

Club

Club

HOME mode operation

If you want to print out race result or gambling lists you could the print functions equal to the CLUB mode.



Gambling (Picked Birds and Nominations)

Available in CLUB, HOME or SINGLE mode.

Prior to the basketing of your pigeons you can store picked birds and nominations for each pigeon into your TIPES® MC1100 clock. Gambling could be done everytime independent to which unit the MC1100 clock is connected (Reading unit, basketing unit, power supply) and which mode is set. Please note that you could only nominate or do picked birds on pigeons which are not basketed or timed in for a race.

Gambling 06. 18:06:21

Nominations
Picked birds

Select the **Gambling** function with the ⇒ ⇐ (right/left) keys

Press the ENTER key

Move the selection bar to the sub menu item of the list you want to print. Press ENTER to select it.

Nominations

Before you could nominate the pigeons you have select for which race they should be nominated.



To select a pigeon from the pigeon list you can use the scroll or the search function. For details please refer to chapter “Allocation during basketing”.

Press the ENTER key to select the pigeon. Pigeons which are not allocated or already basketed couldn't be nominated.

The empty box at the bottom of the display shows you information about the nominations which are done already before.

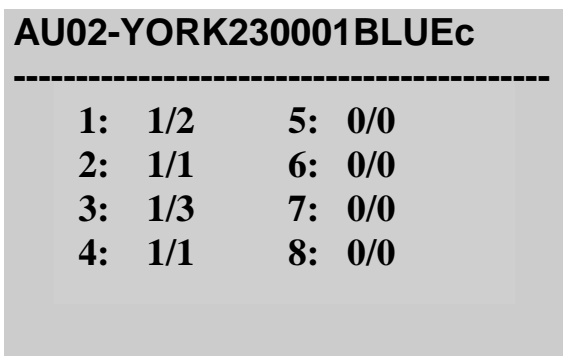

You are able to input 8 different categories of nominations in the range 0 and 1. The number after the slash gives you the information how many pigeons you have already nominated for each category.

The pigeon number which you are nominating is display at the top of the display.

After your input the cursor will automatically switch to the next input field. If you input in category 8 it will automatically store the data and go back to the pigeon selection menu.

Otherwise you can store the input data when you press the RETURN key. If you press the 'C' key the input window will be left and the data isn't stored.

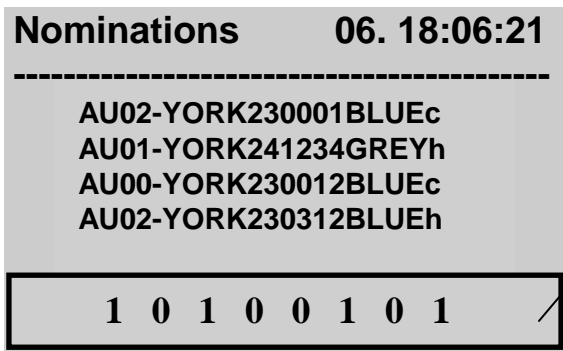

If you want to check your nominations you could go through the pigeon list and look at the information window.

Information Window

Picked birds

Before you could select pigeons for picked birds you have select for which race it should be picked. You could select the picked bird function independently from races. That means for each liberation point (race) you could set new picked birds (001 to ?).



To select a pigeon from the pigeon list you can use the scroll or the search function. For details please refer to chapter "Allocation during basketing".

Press the ENTER key to select the pigeon. Pigeons which are not allocated or already basketed couldn't be picked.

The empty box at the bottom of the display shows you information about the picked birds which are done already before.



If you want to pick the selected pigeon press the ENTER key. If you want to withdraw the pigeon as picked bird press the 0 key. The information window shows you the picked bird number for the selected pigeon.

If you withdraw a picked bird all the other pigeon which belong to the race will be automatically adjusted through the system.



Delete

Available in CLUB, HOME or SINGLE mode.

Every pigeon can only be registered one time. If you want this pigeon to participate in the next race you first have to delete the race data. The delete function could be started from each operation mode (CLUB, HOME or SINGLE).

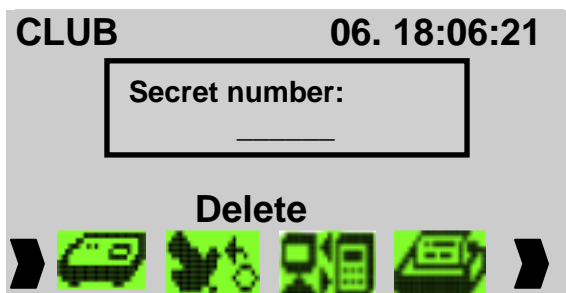

Select the **DELETE** function with the ⇒ ⇐ (right/left) keys

Press the ENTER key

Enter PIN code and press ENTER for confirmation.

The PIN-Code preset from the manufacturer is: 123456 ! If you want to change your PIN-Code refer to chapter pc administration software manual.

The MC1100 clock includes a safety feature which protects the fancier from unintentional deleting his race data.

Basketed pigeons are disabled from deleting. After you print out the race result list the MC1100 clock will release the pigeons for deleting.

No warning will be display if you delete a race. Deleting will be execute immediately and irreversible as far as you confirm the secret code.



Setup

Available in CLUB, HOME or SINGLE mode.

The setup function will be modified in the future, please pay attention to our website (www.motz.de) where the update of the manual is published.

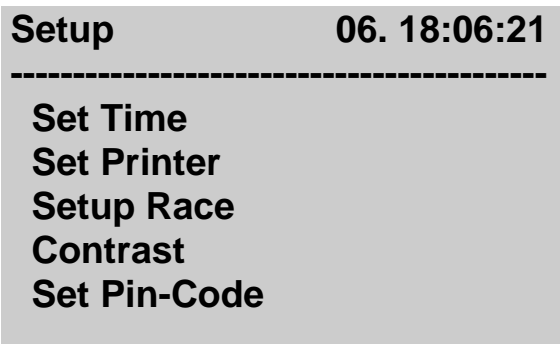

Move the selection bar the race you want to print and press the ENTER key.

Set Time

This submenu gives you the possibility to set date and time manually. Please note that you could run this function only if no race data is stored in MC1100 clock. Otherwise the MC1100 will show you an empty window and it will go back to submenu.

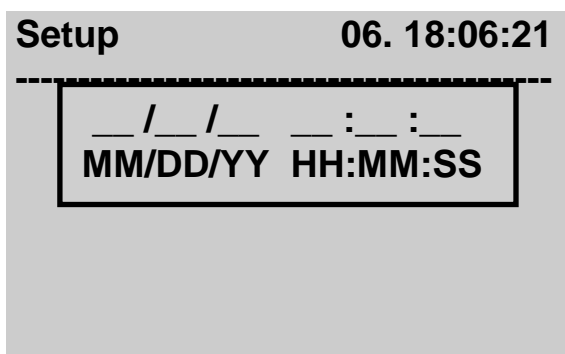

For more details please refer to chapter **Set Time** function description.

Set Printer

Lines per page

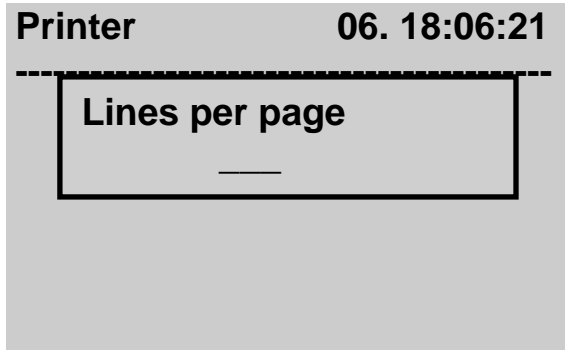

Please enter the number of lines per page you want to print. Press enter to set up.

Setup Race

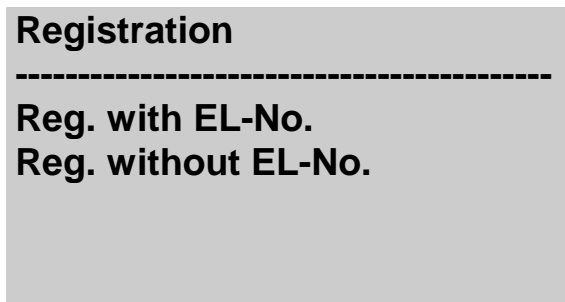

Move the selection bar the race you want to print and press the ENTER key.
Here you have the possibility to setup what numbers you want to register. If you don't like to have birds on your print outs which don't have been allocated than select the second item in the submenu "Registration without el. No."
This setup menu is especially for training races.

Registration of all electronic numbers

If you select this menu item your MC1100 clock will register all electronic numbers, whether they are allocated or not. This function is only activated for training races. On official races not allocated birds won't be clocked. But those rings will be indicated by a different beep. That is a good possibility to test you complete trap system with one not allocated electronic ring.



Training basketing

Available in HOME or SINGLE mode.

This function is for flight simulation.

The pigeon for the flight simulation can be selected at three different points

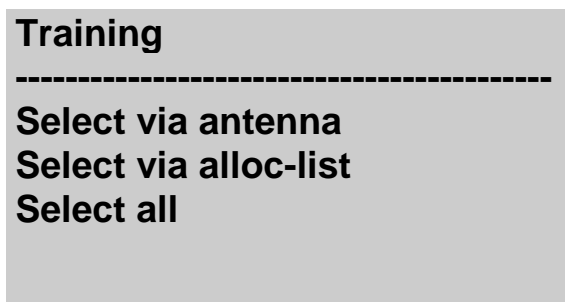



Selftest

Available in CLUB, HOME or SINGLE mode.

Not ready yet.



Time /Date

Available in HOME or SINGLE mode.

The time and date can be set here. If race or basketing data is available, this function is disabled.

Input date and time and press the ENTER key to set date and time.

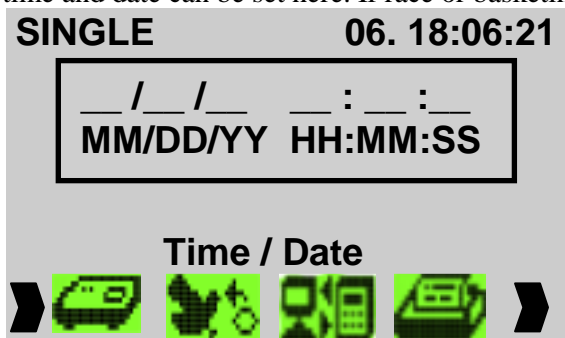

Race Info

Available in HOME or SINGLE mode.

This function gives you an overview of all pigeons setup for races. It shows you the basketed and timed in pigeons. Basketed pigeon have the time stamp 0:00:00.0 and the asterisk (*). Timed in pigeons show the time in time stamp and the quotation mark (!). The information is independent from the race they basketed for.

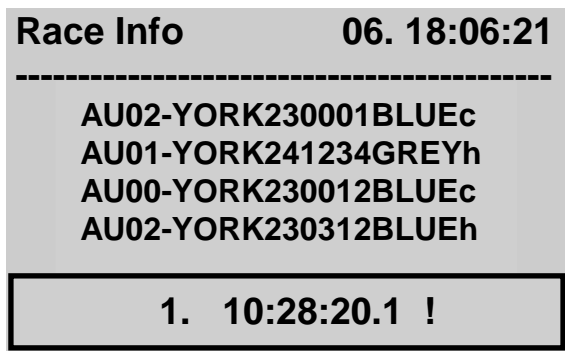

Move the selection bar to the pigeon from which you want to see the race information. The race information is shown in the window on the bottom of the display.

9. Software Update

Please contact your dealer.

10. Direct access functions

The following list give you an overview of the short cut function for direct access to the MC1100 master functions. To activate the short cut function please press key on MC1100 master, which is listed below.

Club Modus	Shortcut
Basketing	1
Knock-Off	2
Allocate	3
PC-COM.	4
Print	5
Basketing List	5 1
Knockoff-List	5 2
Allocation-List	5 3
Arrival-list	5 4
Gambling	6
Nomination	6 1
Picked birds	6 2
Delete	7
Setup	8
Set Time	8 1
Set Printer	8 2
Lines per page	8 3 1
Setup Race	8 4
Reg. with EL-No.	8 4 1
Reg. without EL-No.	8 4 2
Contrast	8 5
Set Pin-Code	8 6
Show License	8 6 1
Print License	8 6 2
Update License	8 6 3
Selftest	9
Home Modus	
Race Info	1
Print	2
Basketing list	2 1
Knockoff-list	2 2
Allocation-list	2 3
Arrival-list	2 4

Gambling	3
Nomination	3 1
Picked birds	3 2
Delete	4
Setup	5
Set Time	5 1
Set Printer	5 2
Lines per page	5 2 1
Setup Race	5 3
Reg. with EL-No.	5 3 1
Reg. without EL-No.	5 3 2
Contrast	5 4
Set Pin-Code	5 5
Show License	5 5 1
Print License	5 5 2
Update License	5 5 3
Training basketing	6
Select via antenna	6 1
Select via alloc-list	6 2
Select all	6 3
Selftest	7
Single Modus	
Race Info	1
Print	2
Basketing list	2 1
Knockoff-list	2 2
Allocation-list	2 3
Arrival-list	2 4
Gambling	3
Nomination	3 1
Picked birds	3 2
Delete	4
Setup	5
Set Time	5 1
Set Printer	5 2
Lines per page	5 2 1
Setup Race	5 3
Reg. with EL-No.	5 3 1
Reg. without EL-No.	5 3 2
Contrast	5 4
Set Pin-Code	5 5
Show License	5 5 1
Print License	5 5 2
Update License	5 5 3
Training basketing	6
Select via antenna	6 1
Select via alloc-list	6 2
Select all	6 3
Selftest	7

11. Dr. MC TIPES

MC1100 is a very reliable system and high quality electronic clocking system for racing pigeon sports. Nevertheless it is possible that the MC1100 clock doesn't work as you would expect. With the help from Dr. MC TIPES, you are capable to solve most questions and problems by yourself in a short time.

If you don't have success and the system is still out of order or your problem is still there, please contact your TIPES dealer or Motz Computer GmbH in Germany.

Problem	possible cause
Gaps are in your print	The printer is too slow and the printer buffer gets an overflow. Setup the printer in „Draft mode”, which enables the printer to print the data in higher speed..
The print contains empty sides	Set the „Auto Form Feed“ switch at your printer to „Off“-position. Please refer to your printer manual or contact your dealer how to do it. Adjust lines of printing in the Setup menu of the MC1100 clock.
No print possible	Test whether at your printers „online “corresponding light is switched on. Check the cable between TIPES system and printer. Use only original cables from the manufacturer. If not please check you pin assignments: RxD-Signal - Pin 2; TxD-Signal - Pin 3; GND - Pin 5
No connected units recognized on the ports (AUX, USTB)	Connection to basketing unit: Please check if the time receiving is active. Wait about 10 seconds before you connect the MC1100 clock to the basketing unit. Communication port is defective. Cable is defective. Connection to reading unit: Power off your MC1100 installation shortly and again one. The problem should not be remedied; you please test, whether all contact-pins in the plug of the cables from the MC1100 to the reading-unit also as at the MC1100 itself correctly protrudes. A pressed in pin can cause the described mistake.
Message „no connection to TIPES “appears on the PC	Test, whether the PC is connected correctly to the master unit Switch on and of the master unit and connect MC1100 clock again. Do you use the right PC communication cable?
Message "SYSTEM ERROR CONTACT SERVICE"	If the message appears a fatal hardware error has occurred you must send the MC1100 clock to TIPES Germany

12. Technical data

- Voltage and frequency
 - 110 - 240 volts ac, 50 - 60 Hz (Power supply)
 - 12 volts dc
- Current load MC1100 only
 - 8-10 Watt at 110 - 240 volts ac
 - max 500mA at 12 volts dc
- Operating temperature range
 - 0° C to +45° C
- Storage temperature
 - - 15° C to + 55° C

- weights and sizes
 - TIPES® MC1100 clock:
200 (l) * 112 (d) * 64(h) mm³, 0,28 kg
 - TIPES® reading unit:
224.2 (l) * 200 (d) * 72.4 (h) mm³, 0,57 kg
 - control unit:
200 (l) * 112 (d) * 64 (h) mm³, 0,48 kg
 - quad-field trap:
568 (l) * 263 (d) * 39 (h) mm³, 4,0 kg

- Accessories
 - mains power supply
 - home cable for USTB connection
 - cable reading unit-control unit 1,5m

13. Guarantee-conditions:

The manufacturer, Motz Computer GmbH, offers the following guarantee to the first purchaser of TIPES® components:

1. The guarantee is valid for **12 months, batteries 6 months**, commencing when the unit is handed over to the purchaser which must be verified by purchaser invoice or similar documentation.
2. The guarantee covers all parts or components which fail due to faulty workmanship or faulty material. The guarantee does not cover TIPES® components where defects or poor performance are due to misuse, faults in the building wire, accidental damage, neglect, faulty installation, unauthorized modification or attempted repair or failure to use the unit in accordance with the operating instructions.
3. Should guarantee repairs be necessary the purchaser must inform the nearest customer service (distributor or authorized service partner).
4. The guarantee or free replacement includes both labor and materials.
5. Repairs carried out under guarantee do not extend the guarantee period. Parts removed during guarantee repairs become the property of Motz Computer GmbH.

14. Imprint

The information contained in this manual is subject to change without notice and as part of Motz-Computer GmbH no obligations. Without prior written permission of Motz-Computer GmbH, it is not allowed to copy either the manual or parts thereof, electronic or mechanical means, photocopying or by other methods or record in any other manner or for transfer.

First Print (12/2011)

TIPES® is a trademark of Motz-Computer GmbH, Germany.

© Copyright 2001 - 2012 Motz-Computer GmbH universe rights reservations

Published from
Motz-Computer GmbH
Revision: 1

Motz-Computer
Service und Vertriebs GmbH
Pfennigbreite 20 - 22
D-37671 Hörter
Germany

Tel. +49 (0)5271/9704-0
Fax.: +49 (0)5271/9704-94
Internet: <http://www.tip.es.de>
E-Mail: tip.es@motz.de